

DrayTek

Vigor2132 Series

Security Giga Router



Quick Start Guide

V1.2

Vigor2132 Series Security Giga Router Quick Start Guide

Version: 1.1

Firmware Version: V3.7.8.2

(For future update, please visit DrayTek web site)

Date: April 27, 2016

Intellectual Property Rights (IPR) Information

Copyrights

© All rights reserved. This publication contains information that is protected by copyright. No part may be reproduced, transmitted, transcribed, stored in a retrieval system, or translated into any language without written permission from the copyright holders.

Trademarks

The following trademarks are used in this document:

- Microsoft is a registered trademark of Microsoft Corp.
- Windows, Windows 95, 98, Me, NT, 2000, XP, 7, 8 and Explorer are trademarks of Microsoft Corp.
- Apple and Mac OS are registered trademarks of Apple Computer Inc.
- Other products may be trademarks or registered trademarks of their respective manufacturers.

Safety Instructions and Approval

Safety Instructions

- Read the installation guide thoroughly before you set up the router.
- The router is a complicated electronic unit that may be repaired only by authorized and qualified personnel. Do not try to open or repair the router yourself.
- Do not place the router in a damp or humid place, e.g. a bathroom.
- Do not stack the routers.
- The router should be used in a sheltered area, within a temperature range of +5 to +40 Celsius.
- Do not expose the router to direct sunlight or other heat sources. The housing and electronic components may be damaged by direct sunlight or heat sources.
- Do not deploy the cable for LAN connection outdoor to prevent electronic shock hazards.
- Keep the package out of reach of children.
- When you want to dispose of the router, please follow local regulations on conservation of the environment.

Warranty

We warrant to the original end user (purchaser) that the router will be free from any defects in workmanship or materials for a period of two (2) years from the date of purchase from the dealer. Please keep your purchase receipt in a safe place as it serves as proof of date of purchase. During the warranty period, and upon proof of purchase, should the product have indications of failure due to faulty workmanship and/or materials, we will, at our discretion, repair or replace the defective products or components, without charge for either parts or labor, to whatever extent we deem necessary to restore the product to proper operating condition. Any replacement will consist of a new or re-manufactured functionally equivalent product of equal value, and will be offered solely at our discretion. This warranty will not apply if the product is modified, misused, tampered with, damaged by an act of God, or subjected to abnormal working conditions. The warranty does not cover the bundled or licensed software of other vendors. Defects which do not significantly affect the usability of the product will not be covered by the warranty. We reserve the right to revise the manual and online documentation and to make changes from time to time in the contents hereof without obligation to notify any person of such revision or changes.

Be a Registered Owner

Web registration is preferred. You can register your Vigor router via <http://www.draytek.com>.

Firmware & Tools Updates

Due to the continuous evolution of DrayTek technology, all routers will be regularly upgraded. Please consult the DrayTek web site for more information on newest firmware, tools and documents.

<http://www.draytek.com>

European Community Declarations

Manufacturer: DrayTek Corp.
Address: No. 26, Fu Shing Road, Hukou Township, Hsinchu Industrial Park, Hsinchu County,
Taiwan 303
Product: Vigor2132 Series Router

DrayTek Corp. declares that Vigor2132FVn is in compliance with the following essential requirements and other relevant provisions of R&TTE 1999/5/EC, ErP 2009/125/EC and RoHS 2011/65/EU.

The product conforms to the requirements of Electro-Magnetic Compatibility (EMC) Directive 2004/108/EC by complying with the requirements set forth in EN55022/Class B and EN55024/Class B.

The product conforms to the requirements of Low Voltage (LVD) Directive 2006/95/EC by complying with the requirements set forth in EN60950-1.

This product is designed for 2.4GHz /5GHz WLAN network throughout the EC region.

Regulatory Information

Federal Communication Commission Interference Statement

This equipment has been tested and found to comply with the limits for a Class B digital device, pursuant to Part 15 of the FCC Rules. These limits are designed to provide reasonable protection against harmful interference in a residential installation. This equipment generates, uses and can radiate radio frequency energy and, if not installed and used in accordance with the instructions, may cause harmful interference to radio communications. However, there is no guarantee that interference will not occur in a particular installation. If this equipment does cause harmful interference to radio or television reception, which can be determined by turning the equipment off and on, the user is encouraged to try to correct the interference by one of the following measures:

- Reorient or relocate the receiving antenna.
- Increase the separation between the equipment and receiver.
- Connect the equipment into an outlet on a circuit different from that to which the receiver is connected.
- Consult the dealer or an experienced radio/TV technician for help.

This device complies with Part 15 of the FCC Rules. Operation is subject to the following two conditions:

- (1) This device may not cause harmful interference, and
- (2) This device may accept any interference received, including interference that may cause undesired operation.

The antenna/transmitter should be kept at least 20 cm away from human body.

Please visit <http://www.draytek.com> for more detailed information.

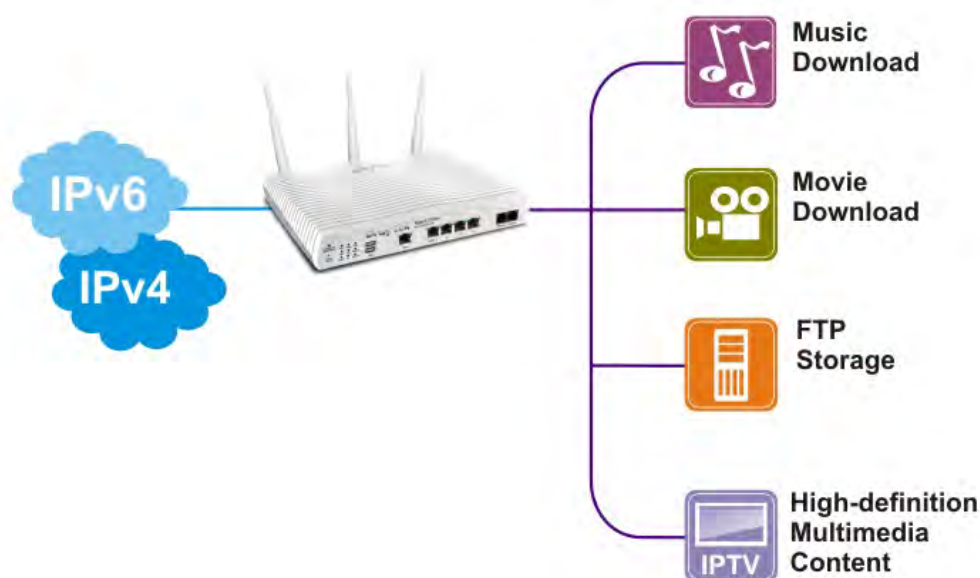

Table of Contents

1. Introduction	1
1.1 Panel Explanation	3
1.1.1 Vigor2132FVn	3
1.1.2 Vigor2132ac/Vac	5
1.2 Package Content	8
2. Installing Your Router	9
2.1 Hardware Installation	9
2.2 Printer Installation	10
3. Basic Settings	19
3.1 Accessing Web Page	19
3.2 Quick Start Wizard	20
3.3 Wireless Configuration	29
3.3.1 Basic Wireless LAN Concept	29
3.3.2 Wireless Wizard	30
3.4 Registering Vigor Router	32
4. Trouble Shooting	35
4.1 Checking If the Hardware Status Is OK or Not	35
4.2 Checking If the Network Connection Settings on Your Computer Is OK or Not	36
4.3 Pinging the Router from Your Computer	40
4.4 Checking If the ISP Settings are OK or Not	41
4.5 Backing to Factory Default Setting If Necessary	42
4.6 Contacting DrayTek	43

1. Introduction

Vigor2132 Series integrates IP layer QoS, NAT session/bandwidth management to help users control works well with large bandwidth.



The entertainment applications running over the home network infrastructure and home-based productivity for SOHO are growing while the broadband bandwidth is increasingly available within affordable budget along with deployment of FTTx. The fiber WAN port of Vigor2132FVn optimizes the throughput performance and flexibility for time-critical console gaming, multi-media streaming and P2P downloading as well as IP telephony. The four Gigabit Ethernet (10/100/1000 LAN ports) auto-sensing ports facilitate home networking with width-intensive applications! Through the combination of Fiber WAN and Gigabit LAN ports to optimize the bandwidth usage, the downstream data and voice packets for Triple play can be flawlessly displayed in endpoint devices, such as HDTV, desktop/laptop or analog/IP phone.

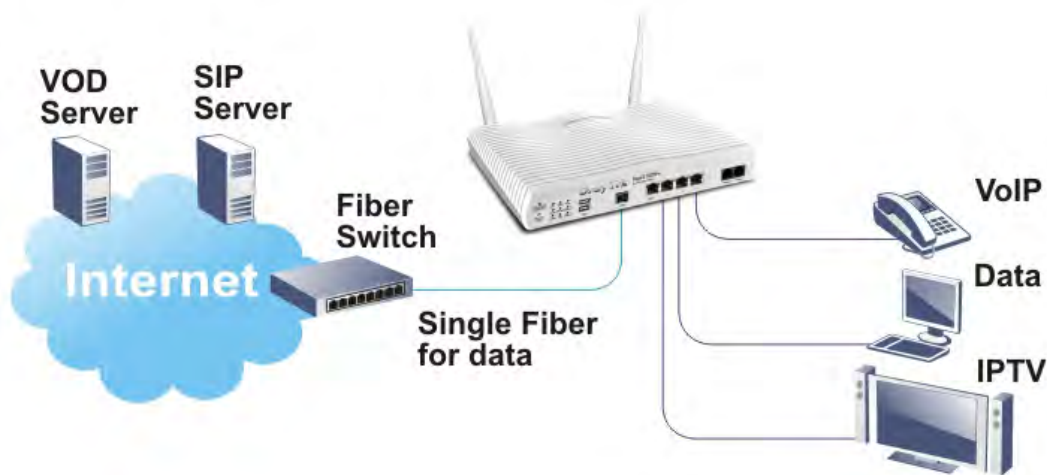

The Vigor2132FVn/Vac/ac series router gives you not only the 802.11n/ac standards for coverage, but also the time scheduling function to save your energy bill plus reducing the carbon footprint. For wireless security, it is also efficient for wireless network management. For instance, its "Wireless LAN isolation" can easily isolate wireless network for friends or guests. Then, the access rights of various wireless clients can be managed by "MAC address control" and deployed "WEP/WPA/WPA2" authentication. No need to remember passwords, you simply press "WPS" button on router and then enable users to securely connect laptop or computers to the router!

The fiber deployment (for Vigor2132FVn) lets businesses and common people have fatter pipe of accessing global network. DrayTek Vigor2132FVn Fiber Router is developed in compliance with the Super-fast broadband architecture and customized for users which already have Fiber to the building (FTTB) or Fiber to the home (FTTH). The bandwidth-consuming multimedia streaming and crystal-clear VoIP functionalities are realized through the Vigor2132FVn's upto-1000Mbps (1 Gigabit) WAN throughput and advanced bandwidth management. You can apply the rules of Session Limit, Bandwidth Limit, Port Rate Control, QoS control list, Ports Priority to different traffic type for better efficiency.

By making the most of your broadband line, the VoIP call will be carried to the destination via Internet. So you can save on the telephone bill. Combining the Internet Telephony service from the Internet Telephony Service Provider (ITSP), the Vigor2132FVn charter VoIP calls to be made to any legacy phone numbers, even including mobile and long distance numbers!

In addition, it supports the worldwide standard TR-069 management and customized triple play while most fiber routers could not have the above distinguished features.

1.1 Panel Explanation

1.1.1 Vigor2132FVn



LED	Status	Explanation
ACT (Activity)	Blinking	The router is powered on and running normally.
	Off	The router is powered off.
USB1/USB2	On	USB device is connected and ready for use.
	Blinking	The data is transmitting.
WAN	On	Internet connection is ready.
	Off	Internet connection is not ready.
	Blinking	The data is transmitting.
WLAN	On	Wireless access point is ready.
	Blinking	It will blink slowly while wireless traffic goes through. ACT and WLAN LEDs blink quickly and simultaneously when WPS is working, and will return to normal condition after two minutes. (You need to setup WPS within 2 minutes.)
VPN	On	The VPN tunnel is active.
	Off	VPN services are disabled
	Blinking	Traffic is passing through VPN tunnel.
Fiber	On	SFP Module is plugged and fiber link is up.
	Off	SFP Module is unplugged or the fiber link is down.
Phone1/ Phone2	On	The phone connected to this port is off-hook.
	Off	The phone connected to this port is on-hook.
	Blinking	A phone call comes.

LED on Connector

LAN1~ LAN4	Left LED	On	The port is connected.
		Off	The port is disconnected.
		Blinking	The data is transmitting.
	Right LED	On	The port is connected with 1000Mbps.
		Off	The port is connected with 10/100Mbps



Interface	Description
Wireless LAN ON/OFF/WPS	<p>Press the button and release it within 2 seconds. When the wireless function is ready, the green LED will be on.</p> <p>Press the button and release it within 2 seconds to turn off the WLAN function. When the wireless function is not ready, the LED will be off.</p> <p>When WPS function is enabled by web user interface, press this button for more than 2 seconds to wait for client's device making network connection through WPS.</p>
Factory Reset	<p>Restore the default settings. Usage: Turn on the router (ACT LED is blinking). Press the hole and keep for more than 5 seconds. When you see the ACT LED begins to blink rapidly than usual, release the button. Then the router will restart with the factory default configuration.</p>
USB1~USB2	<p>Connector for a USB device.</p>
WAN	<p>Fiber connection (100/1000Mbps) for accessing the Internet.</p> 
LAN1~LAN4	<p>Connectors for local network devices.</p>
Phone1~ Phone2	<p>Connector for analog phone(s).</p>
PWR	<p>Connector for a power adapter.</p>
ON/OFF	<p>Power Switch.</p>

1.1.2 Vigor2132ac/Vac

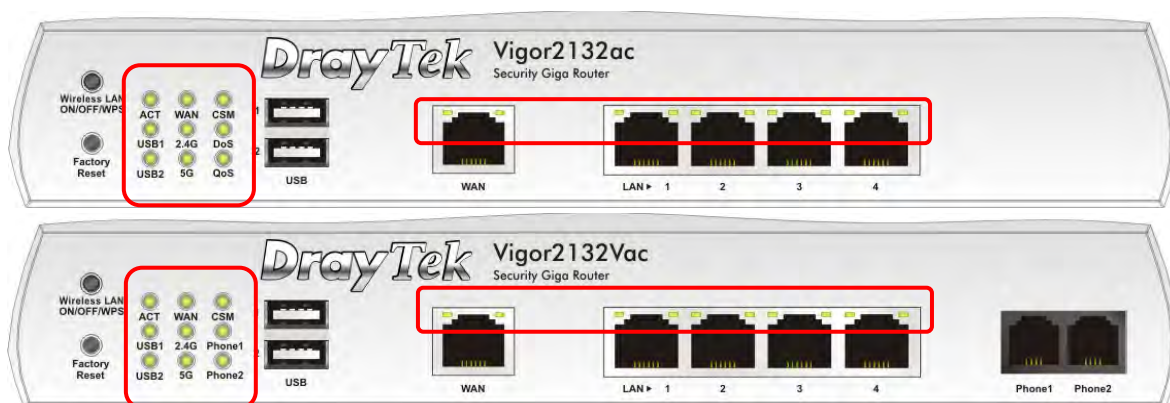

LED	Status	Explanation
ACT (Activity)	Blinking	The router is powered on and running normally.
	Off	The router is powered off.
USB1~USB2	On	USB device is connected and ready for use.
	Blinking	The data is transmitting.
WAN	On	Internet connection is ready.
	Off	Internet connection is not ready.
	Blinking	The data is transmitting.
2.4G/5G	On	Wireless access point with bandwidth of 2.4GHz/5GHz is ready.
	Blinking	It will blink slowly while wireless traffic goes through. ACT and WLAN LEDs blink quickly and simultaneously when WPS is working, and will return to normal condition after two minutes. (You need to setup WPS within 2 minutes.)
CSM	On	The profile(s) of CSM (Content Security Management) for IM/P2P, URL/Web Content Filter application can be enabled from Firewall >>General Setup . (Such profile must be established under CSM menu).
DoS	On	The DoS function is active.
	Blinking	It will blink while detecting an attack.
QoS	On	The QoS function is active.
Phone1 ~ Phone2	On	The phone connected to this port is off-hook.
	Off	The phone connected to this port is

		on-hook.
	Blinking	A phone call comes.

LED on Connector

WAN	Left LED	On	The port is connected.
		Off	The port is disconnected.
		Blinking	The data is transmitting.
	Right LED	On	The port is connected with 1000Mbps.
		Off	The port is connected with 10/100Mbps
	LAN1~ LAN4	Left LED	On
Off			The port is disconnected.
Blinking			The data is transmitting.
Right LED		On	The port is connected with 1000Mbps.
		Off	The port is connected with 10/100Mbps

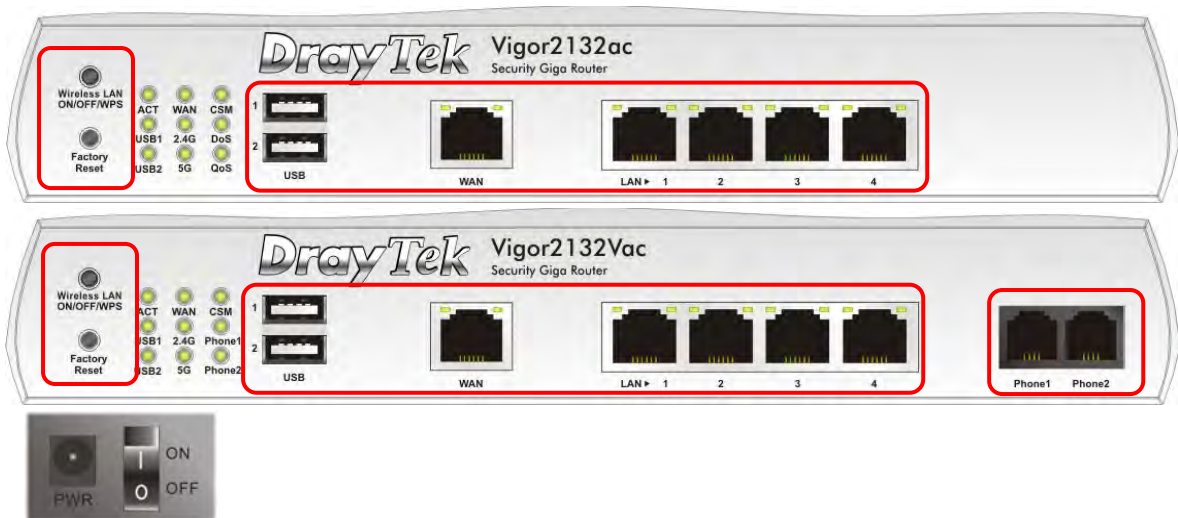

Interface	Description
Wireless LAN ON/OFF/WPS	<p>Press the button and release it within 2 seconds. When the wireless function is ready, the green LED will be on.</p> <p>Press the button and release it within 2 seconds to turn off the WLAN function. When the wireless function is not ready, the LED will be off.</p> <p>When WPS function is enabled by web user interface, press this button for more than 2 seconds to wait for client's device making network connection through WPS.</p>
Factory Reset	<p>Restore the default settings. Usage: Turn on the router (ACT LED is blinking). Press the hole and keep for more than 5 seconds. When you see the ACT LED begins to blink rapidly than usual, release the button. Then the router will restart with the factory default configuration.</p>
USB1~USB2	<p>Connector for a USB device.</p>
WAN	<p>Connector for local network devices or modem for accessing Internet.</p>
LAN1~LAN4	<p>Connectors for local network devices.</p>
Phone1~ Phone2	<p>Connector for analog phone(s).</p>
PWR	<p>Connector for a power adapter.</p>
ON/OFF	<p>Power Switch.</p>

1.2 Package Content

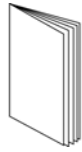

1 Quick Start Guide

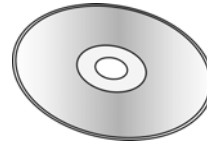

2 CD

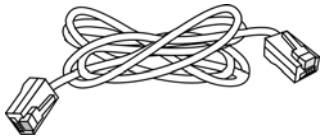

3 RJ-45 Cable (Ethernet)

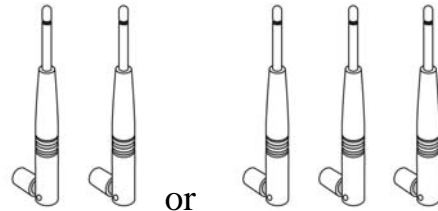

**4 Antenna x 2(n model)
Antenna x 3(ac model)**

- 5** The type of the power adapter depends on the country that the router will be installed:

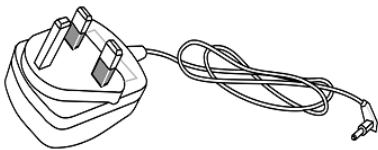

UK-type Power Adapter

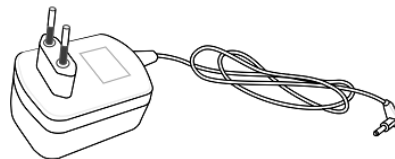

EU-type Power Adapter

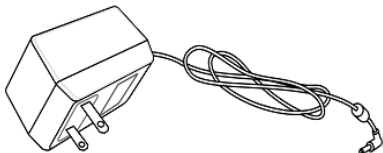

**USA/Taiwan-type Power
Adapter**

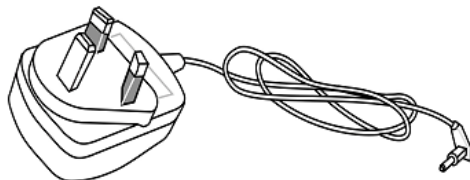

AU/NZ-type Power Adapter

* The maximum power consumption is **24 Watt**.

2. Installing Your Router

This section will guide you to install the router through hardware connection and configure the router's settings through web browser.

2.1 Hardware Installation

Before starting to configure the router, you have to connect your devices correctly.

1. Connect the cable Modem/DSL Modem/Media Converter to any WAN port of router with Ethernet cable (RJ-45).
2. Connect one end of an Ethernet cable (RJ-45) to one of the LAN ports of the router and the other end of the cable (RJ-45) into the Ethernet port on your computer.
3. Connect one end of the power adapter to the router's power port on the rear panel, and the other side into a wall outlet.
4. Power on the device by pressing down the power switch on the rear panel.
5. The system starts to initiate. After completing the system test, the **ACT** LED will light up and start blinking.

(For the detailed information of LED status, please refer to section 1.1.)

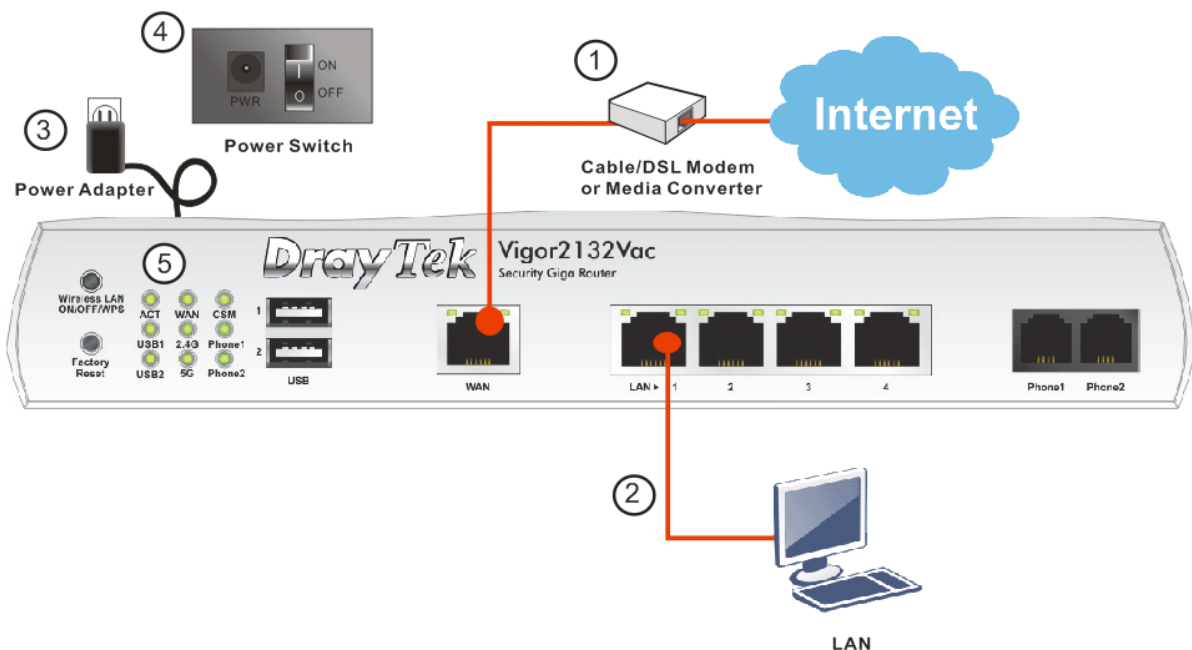

2.2 Printer Installation

You can install a printer onto the router for sharing printing. All the PCs connected this router can print documents via the router. The example provided here is made based on Windows 7. For other Windows system, please visit www.DrayTek.com.

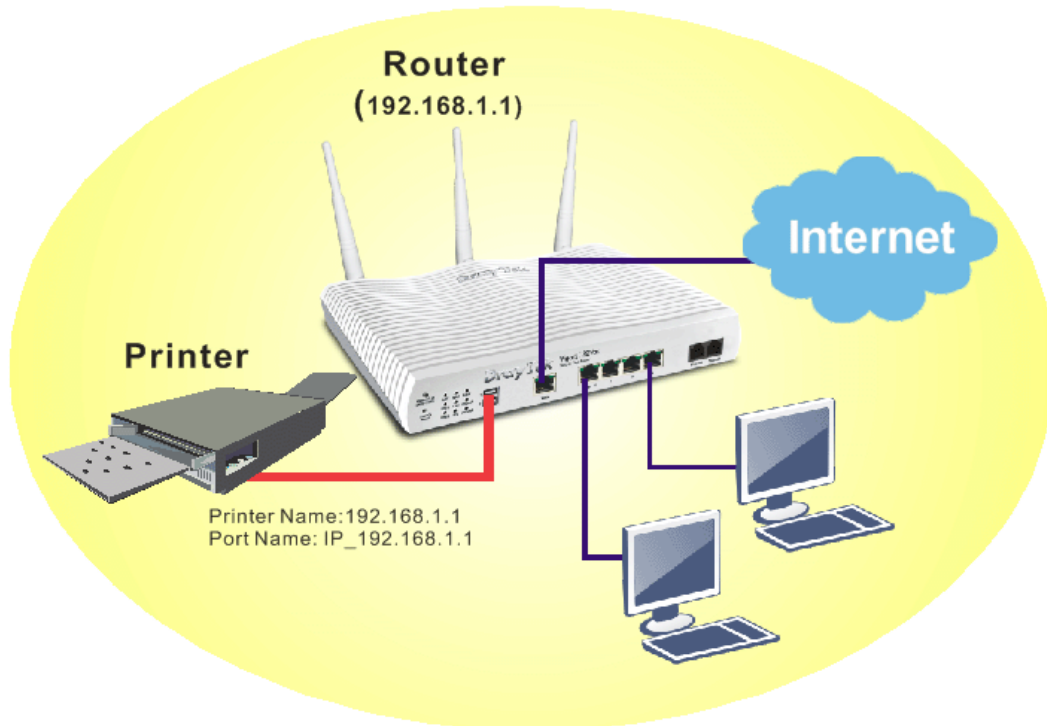

Before using it, please follow the steps below to configure settings for connected computers (or wireless clients).

1. Connect the printer with the router through USB/parallel port.
2. Open **All Programs>>Getting Started>>Devices and Printers**.

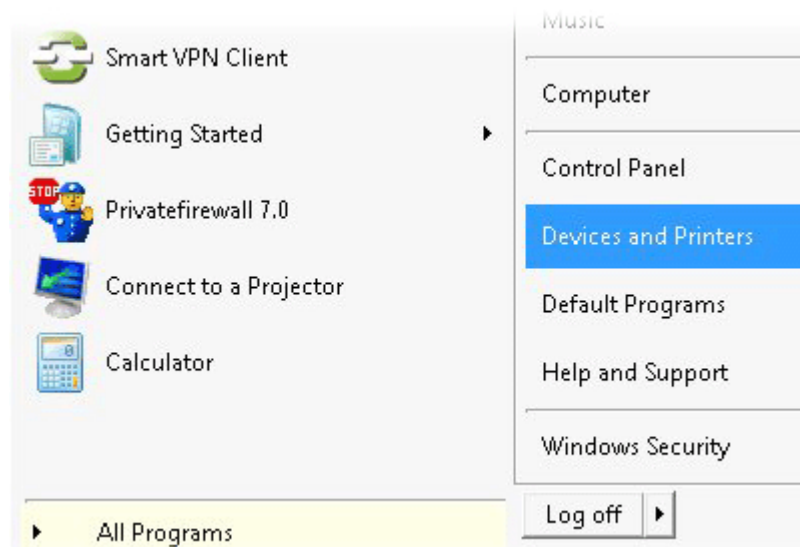

3. Click **Add a printer**.

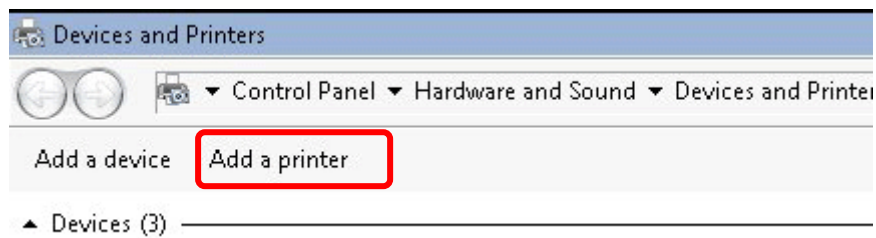

4. A dialog will appear. Click **Add a local printer** and click **Next**.

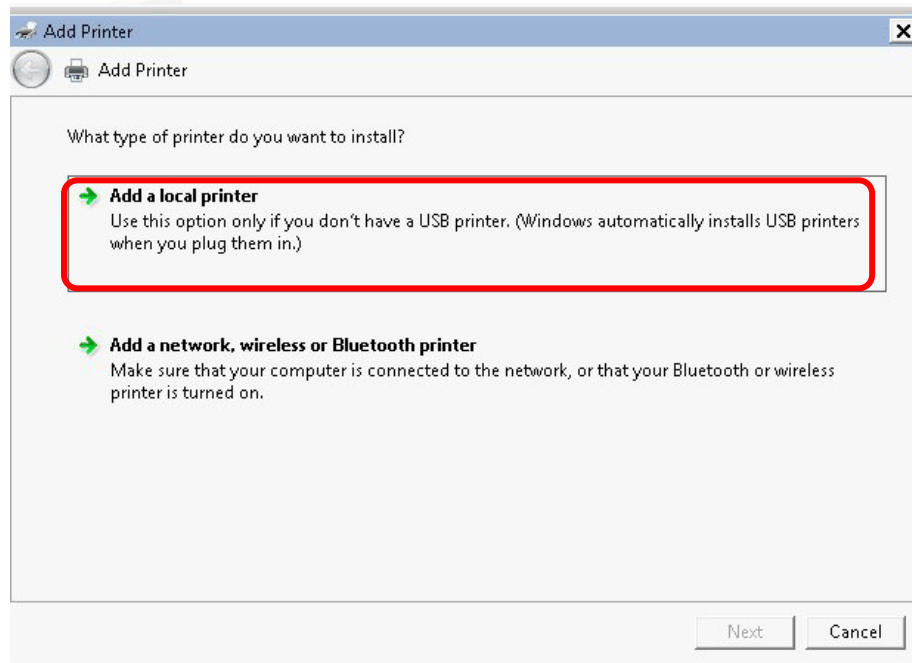

5. In this dialog, choose **Create a new port**. In the field of **Type of port**, use the drop down list to select **Standard TCP/IP Port**. Then, click **Next**.

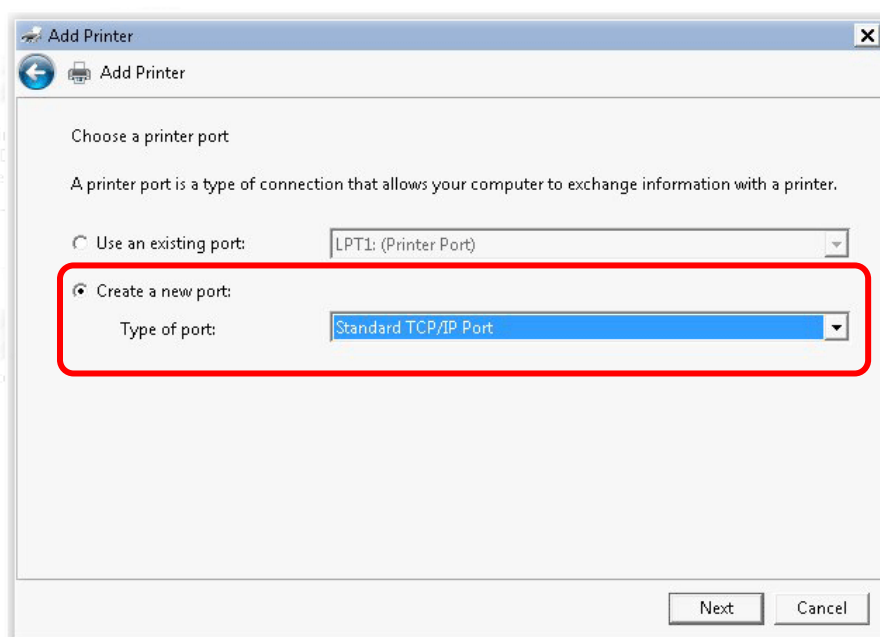

6. In the following dialog, type **192.168.1.1** (router's LAN IP) in the field of **Hostname or IP Address** and type **192.168.1.1** as the **Port name**. Then, click **Next**.

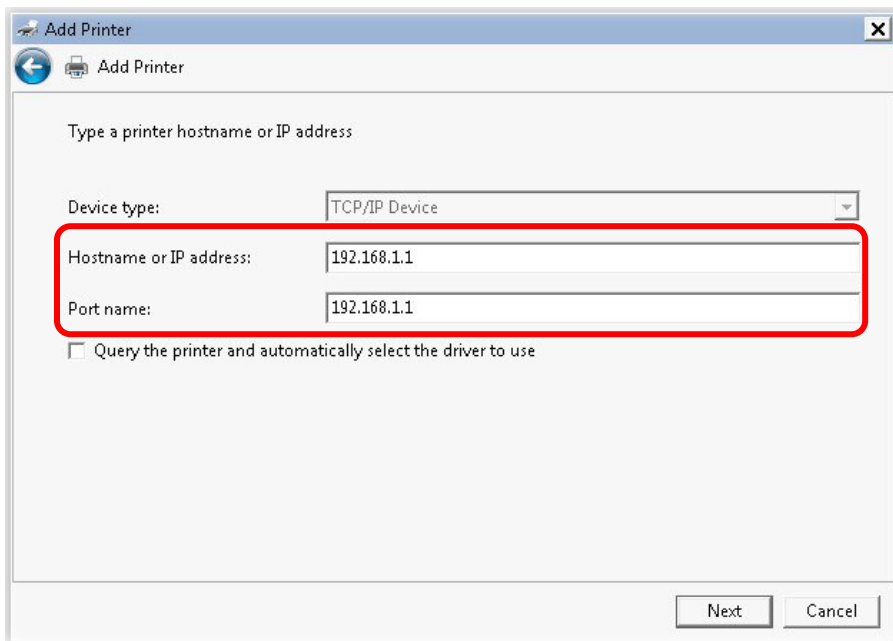

7. Click **Standard** and choose **Generic Network Card**.

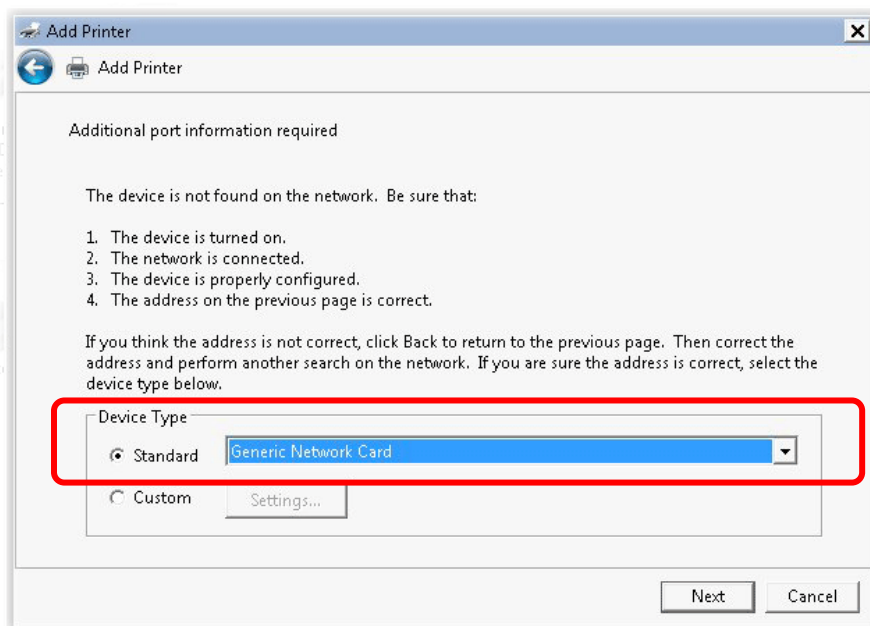

8. Now, your system will ask you to choose right name of the printer that you installed onto the router. Such step can make correct driver loaded onto your PC. When you finish the selection, click **Next**.

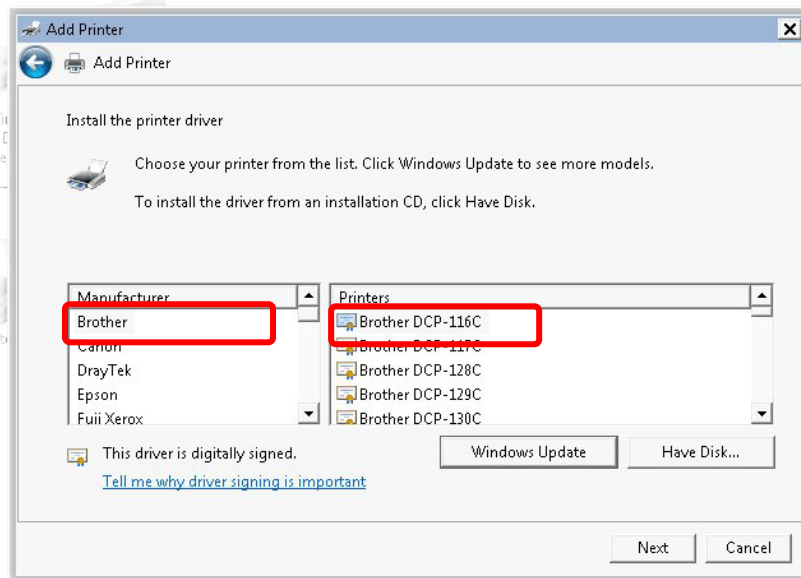

9. Type a name for the chosen printer. Click **Next**.

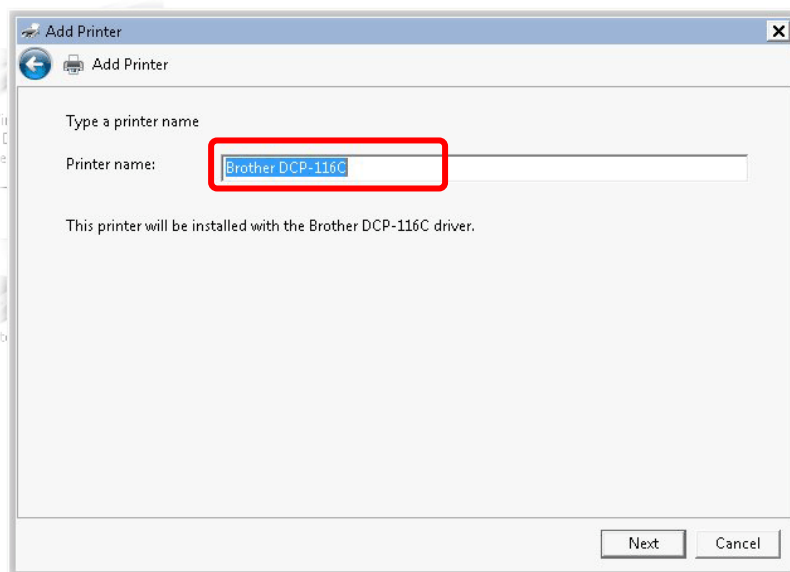

10. Choose **Do not share this printer** and click **Next**.

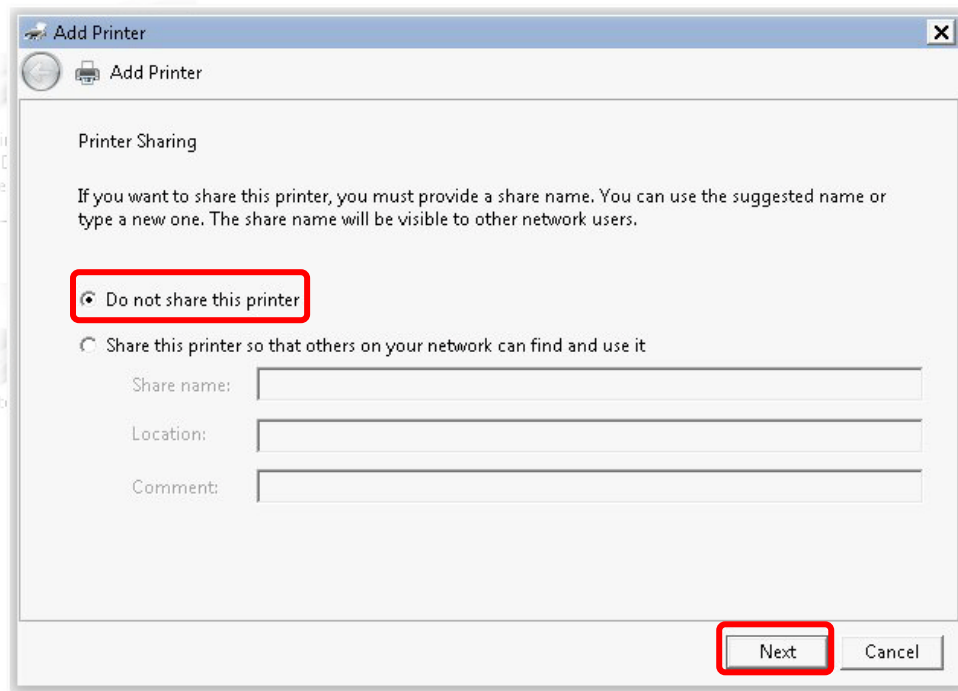

11. Then, in the following dialog, click **Finish**.

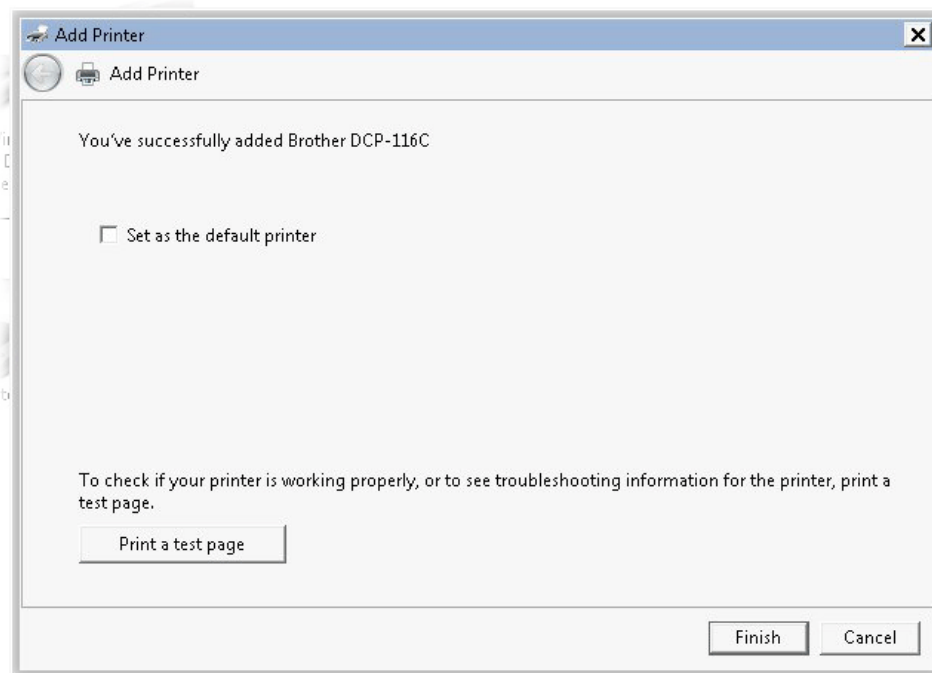

12. The new printer has been added and displayed under **Printers and Faxes**. Click the new printer icon and click **Printer server properties**.

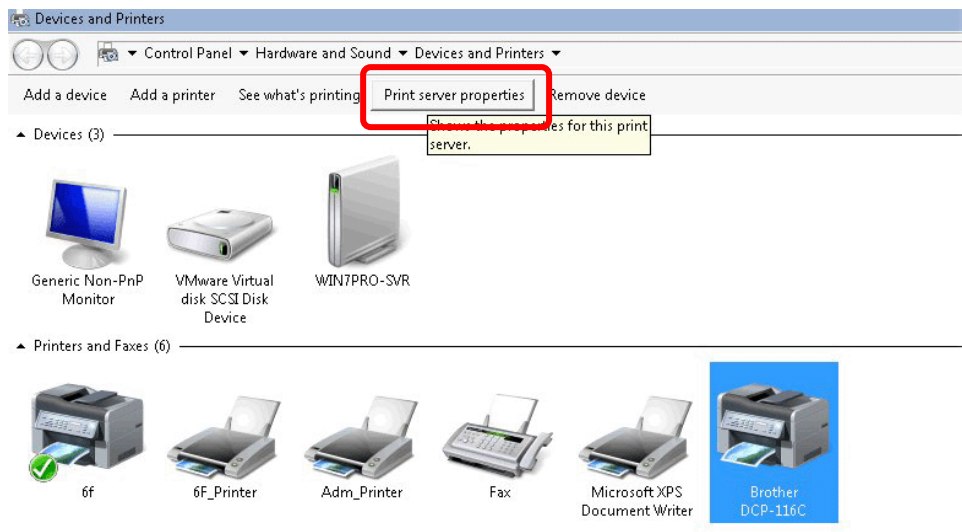

13. Edit the property of the new printer you have added by clicking **Configure Port**.

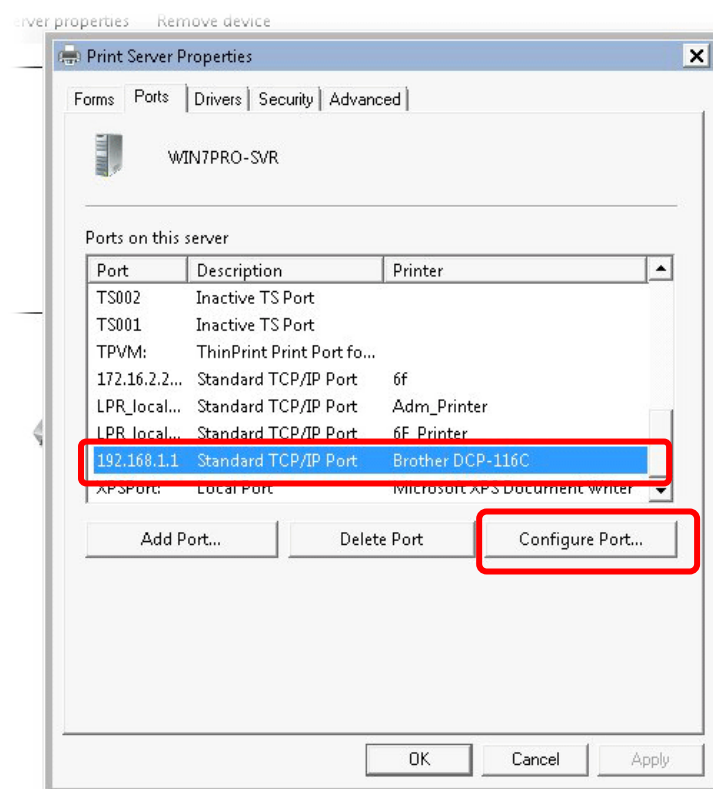

14. Select "**LPR**" on Protocol, type **p1** (number 1) as **Queue Name**. Then click **OK**. Next please refer to the red rectangle for choosing the correct protocol and LPR name.

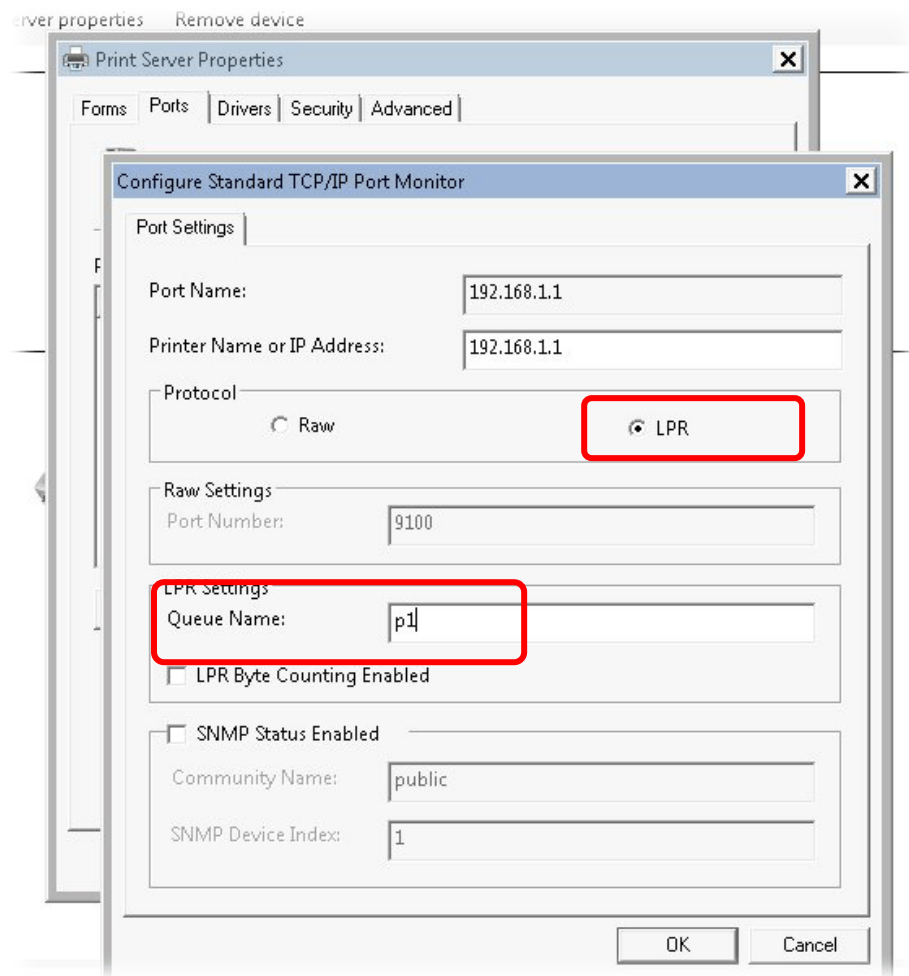

The printer can be used for printing now. Most of the printers with different manufacturers are compatible with vigor router.

Note 1: Some printers with the fax/scanning or other additional functions are not supported. If you do not know whether your printer is supported or not, please visit www.draytek.com to find out the printer list. Open **Support >FAQ/Application Notes**; find out the link of **USB>>Printer Server** and click it.

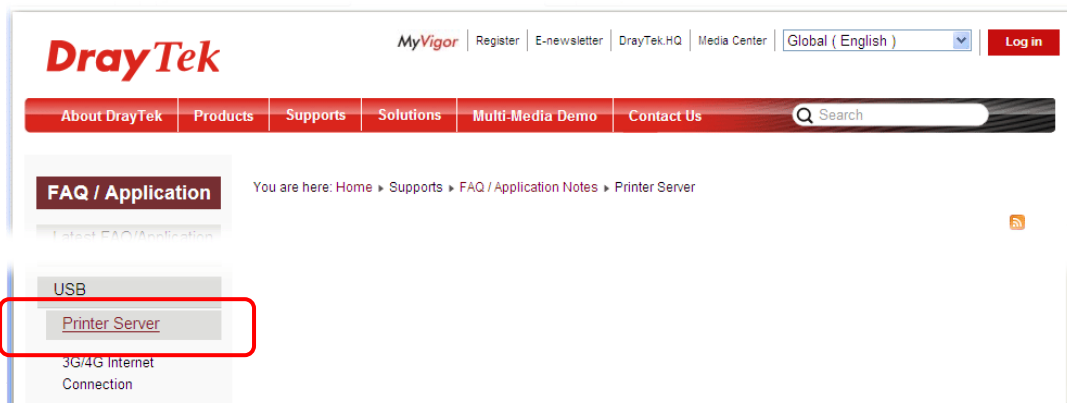

Then, click the **What types of printers are compatible with Vigor router?** link.



Note 2: Vigor router supports printing request from computers via LAN ports but not WAN port.

This page is left blank.

3. Basic Settings

To access Internet, please finish basic configuration after completing the hardware installation.

3.1 Accessing Web Page

1. Make sure your PC connects to the router correctly.



Notice: You may either simply set up your computer to get IP dynamically from the router or set up the IP address of the computer to be the same subnet as **the default IP address of Vigor router 192.168.1.1**. For the detailed information, please refer to the later section - Trouble Shooting of this manual.

2. Open a web browser on your PC and type **http://192.168.1.1**. The following window will be open to ask for username and password. Please type “**admin/admin**” on Username/Password and click **Login**.

The screenshot shows the login interface for a DrayTek Vigor2132 Series router. At the top, there is a red banner with the 'DrayTek' logo on the left and 'Vigor2132 Series' on the right. Below this banner, the word 'Login' is written in white on a dark background. The main area is white and contains two input fields. The first is labeled 'Username' and contains the text 'admin'. The second is labeled 'Password' and contains six asterisks. Below the password field is a grey button labeled 'Login'.



Notice: If you fail to access to the web configuration, please go to “Trouble Shooting” for detecting and solving your problem.

3. Now, the **Main Screen** will pop up.

- The web page can be logged out according to the chosen condition. The default setting is **Auto Logout**, which means the web configuration system will logout after five minutes without any operation. Change the setting for your necessity.

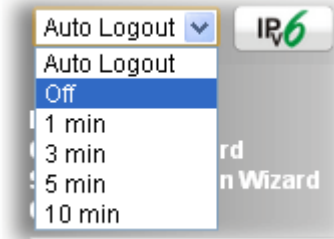

3.2 Quick Start Wizard

The **Quick Start Wizard** is designed for you to easily set up your router for Internet access. You can access **Wizards>>Quick Start Wizard** via Web User Interface.

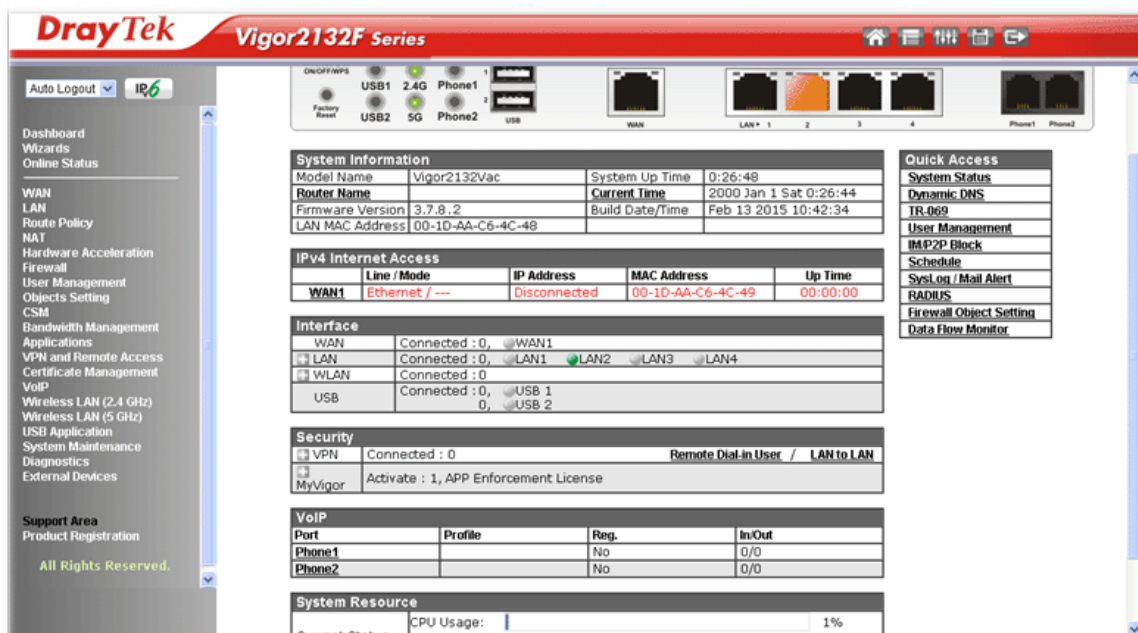

The home page will change slightly in accordance with the router model you have.

If your router can be under an environment with high speed NAT, the configuration provide here can help you to deploy and use the router quickly. The first screen of **Quick Start Wizard** is entering login password. After typing the password, please click **Next**.

Quick Start Wizard

Enter login password

Please enter an alpha-numeric string as your **Password** (Max 23 characters).

Old Password	<input type="password" value="....."/>
New Password	<input type="password" value="....."/>
Confirm Password	<input type="password" value="....."/>

On the next page, please select the appropriate Internet access type according to the information from your ISP. For example, you should select PPPoE mode if the ISP provides you PPPoE interface.

PPPoE

1. After finished the password settings, click the **Next** button. The following page will be open for you to specify Internet Access Type. Click **PPPoE** as the Internet Access Type and click **Next**.

Quick Start Wizard

Connect to Internet

WAN 1
Select one of the following Internet Access types provided by your ISP.

- PPPoE
- PPTP
- L2TP
- Static IP
- DHCP

2. Please manually enter the Username/Password provided by your ISP. Then, click the **Next** button.

Quick Start Wizard

PPPoE Client Mode

WAN 1
Enter the user name and password provided by your ISP.

Service Name (Optional)	CHT
Username	84005657@hinet.net
Password	*****
Confirm Password	*****

3. A summary page of such connection will be shown on the screen.

Quick Start Wizard

Please confirm your settings:

WAN Interface:	WAN1
Physical Mode:	0
Physical Type:	Auto negotiation
Internet Access:	PPPoE

Click **Back** to modify changes if necessary. Otherwise, click **Finish** to save the current settings and restart the Vigor router.

4. Click **Finish**. A page of **Quick Start Wizard Setup OK!!!** will appear. Then, the system status of this protocol will be shown.

Quick Start Wizard Setup OK!

5. Now, you can enjoy surfing on the Internet.

PPTP/L2TP

1. After finished the password settings, click the **Next** button. The following page will be open for you to specify Internet Access Type. Click **PPTP** or **L2TP** as the Internet Access Type and click **Next**.

Quick Start Wizard

Connect to Internet

WAN 1
Select one of the following Internet Access types provided by your ISP.

- PPPoE
- PPTP
- L2TP
- Static IP
- DHCP

2. Please type in the IP address/mask/gateway information originally provided by your ISP. Then click **Next** for viewing summary of such connection.

Quick Start Wizard

PPTP Client Mode

WAN 1
Enter the username, password, WAN IP configuration and PPTP server IP provided by your ISP.

Username

Password

Confirm Password

WAN IP Configuration

- Obtain an IP address automatically
- Specify an IP address

IP Address

Subnet Mask

Gateway

PPTP Server

3. A summary page of such connection will be shown on the screen.

Quick Start Wizard

Please confirm your settings:

WAN Interface:	WAN1
Physical Mode:	0
Physical Type:	Auto negotiation
Internet Access:	PPTP

Click **Back** to modify changes if necessary. Otherwise, click **Finish** to save the current settings and restart the Vigor router.

4. Click **Finish**. A page of **Quick Start Wizard Setup OK!!!** will appear. Then, the system status of this protocol will be shown.

Quick Start Wizard Setup OK!

5. Now, you can enjoy surfing on the Internet.

Static IP

1. After finished the password settings, click the **Next** button. The following page will be open for you to specify Internet Access Type. Click **Static IP** as the Internet Access Type and click **Next**.

Quick Start Wizard

Connect to Internet

WAN 1
Select one of the following Internet Access types provided by your ISP.

- PPPoE
- PPTP
- L2TP
- Static IP
- DHCP

2. Please type in the IP address information originally provided by your ISP. Then click **Next** for next step.

Quick Start Wizard

Static IP Client Mode

WAN 1
Enter the Static IP configuration provided by your ISP.

WAN IP	<input type="text" value="172.16.3.123"/>
Subnet Mask	<input type="text" value="255.255.255.0"/>
Gateway	<input type="text" value="172.16.3.1"/>
Primary DNS	<input type="text" value="undefined"/>
Secondary DNS	<input type="text" value="undefined"/> (optional)

3. A summary page of such connection will be shown on the screen.

Quick Start Wizard

Please confirm your settings:

WAN Interface:	WAN1
Physical Mode:	0
Physical Type:	Auto negotiation
Internet Access:	Static IP

Click **Back** to modify changes if necessary. Otherwise, click **Finish** to save the current settings and restart the Vigor router.

4. Click **Finish**. A page of **Quick Start Wizard Setup OK!!!** will appear. Then, the system status of this protocol will be shown.

Quick Start Wizard Setup OK!

5. Now, you can enjoy surfing on the Internet.

DHCP

1. After finished the password settings, click the **Next** button. The following page will be open for you to specify Internet Access Type. Click **DHCP** as the Internet Access Type and click **Next**.

Quick Start Wizard

Connect to Internet

WAN 1
Select one of the following Internet Access types provided by your ISP.

- PPPoE
- PPTP
- L2TP
- Static IP
- DHCP

2. Type the host name (optional) and click **Next** to continue.

Quick Start Wizard

DHCP Client Mode

WAN 1
If your ISP requires you to enter a specific host name or specific MAC address, please enter it in.

Host Name (optional)

MAC - - - - - (optional)

3. A summary page of such connection will be shown on the screen.

Quick Start Wizard

Please confirm your settings:

WAN Interface:	WAN1
Physical Mode:	Ethernet
Physical Type:	Auto negotiation
Internet Access:	DHCP

Click **Back** to modify changes if necessary. Otherwise, click **Finish** to save the current settings and restart the Vigor router.

4. Click **Finish**. A page of **Quick Start Wizard Setup OK!!!** will appear. Then, the system status of this protocol will be shown.

Quick Start Wizard Setup OK!

5. Now, you can enjoy surfing on the Internet.

3.3 Wireless Configuration

For operating Vigor router well, it is necessary for you to set the wireless LAN settings for using wireless function. Please read the following section carefully for configuring the settings for this router.

(The default value of Frequency Domain was set by factory depends on the reselling region.)

3.3.1 Basic Wireless LAN Concept

In an Infrastructure Mode of wireless network, Vigor wireless router plays a role as an **Access Point (AP)** connecting to lots of wireless clients or Stations (STA). All the STAs (clients) will share the same Internet connection with other wired hosts via Vigor wireless router.

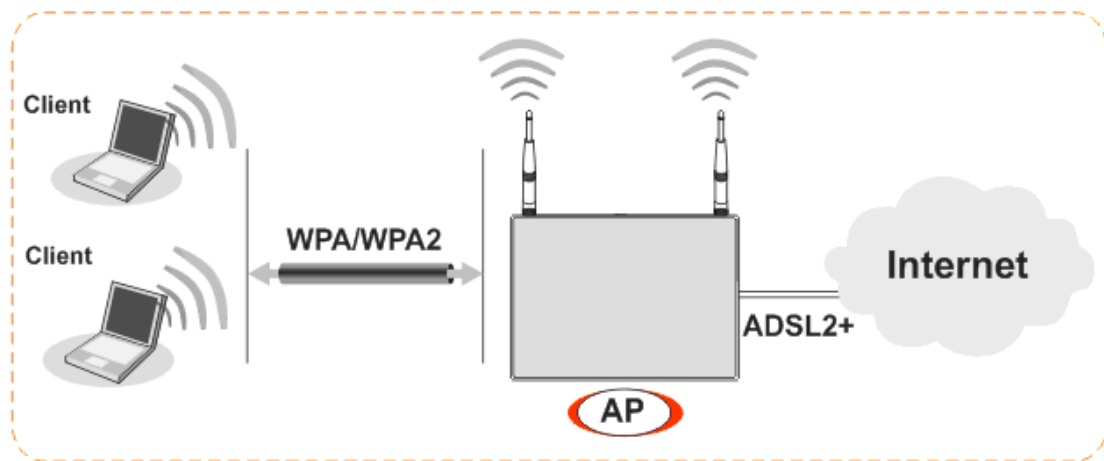

3.3.2 Wireless Wizard

The wireless wizard allows you to configure settings specified for a host AP (for home use or internal use for a company) and specified for a guest AP (for any wireless clients accessing into Internet).

1. Open **Wireless Wizard**.

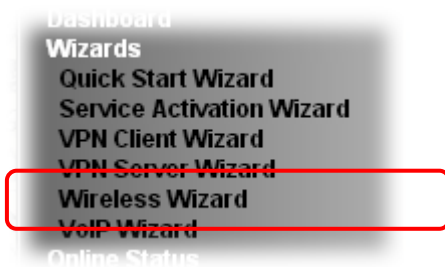

2. The screen of wireless wizard will be shown as follows. This page will be used for *internal users in a company or your home*. Type the required data offered by your ISP.

Wireless Wizard

Host AP Configuration

Wireless 2.4GHz Settings

Name:

Mode:

Channel:

Security Key:

Wireless 5GHz Settings

Use the same SSID and Security Key as above

Name:

Mode:

Channel:

Security Key:

Note: The host AP configured here will be used for home or internal company use.

For the wireless client who wants to access into Internet through such router, please **input the security key** value for connection.

Default Pre-Shared Key (PSK) with 13 ASCII characters is provided and stated on the label pasted on the bottom of the router.

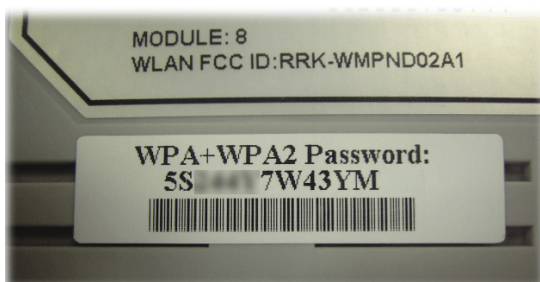

Note that, for the communication, all wireless devices must support the same encryption bit length and share the same key. If WEP mode is selected, only one of four preset keys can be selected at one time.

3. After typing the required information, click **Next**. The settings in the page limit the wireless station (guest) *accessing into Internet but not being allowed to share the LAN network and VPN connection*.

Wireless Wizard

Guest AP Configuration

Wireless 2.4GHz Settings
 Enable Disable
 SSID:
 Security Key:
 Rate Control: Enable Upload kbps Download kbps

Wireless 5GHz Settings
 Enable Disable
 Use the same SSID and Security Key as above
 SSID:
 Security Key:
 Rate Control: Enable Upload kbps Download kbps

Note: The configured guest AP will not be able to access the LAN network, VPN connections, or communicate with wireless devices connecting to the router's other APs. This AP interface shall be used for Internet access only.

Note: Security Key(s) defined for Host AP and Guest AP must be different to avoid that guest accesses into internal server in a company.

4. After typing the required information, click **Next**.
5. The following page will display the configuration summary for wireless setting.

Wireless Wizard

Configuration Summary

Wireless 2.4GHz Settings	Wireless 5GHz Settings
Mode: Mixed(11b+11g+11n) Channel: Channel 6, 2437MHz	Mode: Mixed (11a+11n+11ac) Channel: Channel 36, 5180MHz
Host AP SSID Name: DrayTek Security Key: *****	Host AP SSID Name: DrayTek_5G Security Key: *****
Guest AP Status: Disabled SSID Name: DrayTek_Guest Security Key: ***** Rate Control: Disabled	Guest AP Status: Disabled SSID Name: DrayTek_5G_Guest Security Key: ***** Rate Control: Disabled

6. Click **Finish** to complete the wireless settings configuration.

3.4 Registering Vigor Router

You have finished the configuration of **Quick Start Wizard** and you can surf the Internet at any time. Now it is the time to register your Vigor router to MyVigor website for getting more service. Please follow the steps below to finish the router registration.

1. Please login the web configuration interface of Vigor router by typing “**admin/admin**” as User Name / Password.



The screenshot shows the login interface for a DrayTek Vigor2132 Series router. At the top, there is a red banner with the 'DrayTek' logo on the left and 'Vigor2132 Series' on the right. Below this banner is a black bar with the word 'Login' in white. The main area is white and contains two input fields: 'Username' with the text 'admin' and 'Password' with masked characters (dots). A 'Login' button is positioned below the password field.

2. Click **Support Area>>Production Registration** from the home page.



3. A **Login** page will be shown on the screen. Please type the account and password that you created previously. And click **Login**.



Please take a moment to register.

Membership Registration entitles you to upgrade firmware for your purchased product and receive news about upcoming products and services!

Once you receive the DrayTek membership, welcome your further login to advise us of your opinion about DrayTek product. Your precious suggestions will be of further help for innovation and enhancement. By joining MyVigor, your data will be handled carefully and not passed onto any 3rd party unrelated organizations. Your data will only be used/accessed by DrayTek Corp and regional offices/agents within your own country.

LOGIN

Language : English

UserName :

Password :

Auth Code :

[Forgotten password?](#)

Don't have a MyVigor Account ? [Create an account now](#)

Become the MyVigor member, you can receive the e-newsletter update.
 Please join customer survey after you are a member! Your opinion is very appreciated.



Notice: If you haven't an accessing account, please refer to section 3.8 Creating an Account for MyVigor on User's Guide to create your own one. Please **read the articles on the Agreement regarding user rights** carefully while creating a user account.

4. The following page will be displayed after you logging in MyVigor. From this page, please click **Add** or **Product Registration**.

DrayTek
Login User : carrieni (Logout)
MyVigor

- About Us
- My Information
 - My Product
 - My Password
 - My Settings
- Vigor Series
 - Product Registration**
 - Customer Survey

My Information - My Products

Welcome, **carrieni**

Last login time : 2015-02-25 10:00:31

Last login from : 220.132.109.130

Current login time : 2015-03-04 13:35:34

Current login from : 220.132.109.130

My Device List

Serial Number / Host ID	Device Name	Model	Note
111900325027	2130	Vigor2130	-
2013030811172502	vigor2760	Vigor2760	-

Rows : 10 Page : 1

- When the following page appears, please type in Nickname (for the router) and choose the right registration date from the popup calendar (it appears when you click on the box of Registration Date). After adding the basic information for the router, please click **Submit**.

DrayTek Login User : carrieni (Logout) MyVigor

My Information - My Products

Registration Device

Registration Date : * 03-04-2015

Serial number : 2015030413341201

Nickname : * Vigor2132ac

Usage : -- Select

Product Rating : -- Select (Your opinion so far)

No. of Employees : -- Select (In total within your company)

Supplier : (Where you bought it from)

Date of Purchase : (mm-dd-yyyy)

Internet Connection : *

Cable ADSL VDSL Fiber

3G WIMAX LTE

Cancel Submit

- When the following page appears, your router information has been added to the database.

Your device has been successfully added to the database.



- Now, you have finished the product registration.
- After clicking **OK**, you will see the following page. Your router has been registered to *myvigor* website successfully.

DrayTek Login User : carrieni (Logout) MyVigor

My Information - My Products

Welcome, **carrieni**

Last login time : 2015-02-25 10:00:31
 Last login from : 220.132.109.130
 Current login time : 2015-03-04 13:35:34
 Current login from : 220.132.109.130

Rows : 10 Page : 1

My Device List

Serial Number / Host ID	Device Name	Model	Note
111900325027	2130	Vigor2130	-
2013030811172502	vigor2760	Vigor2760	-
2015022415571701	Vigor2132ac	Vigor2132	-

4. Trouble Shooting

This section will guide you to solve abnormal situations if you cannot access into the Internet after installing the router and finishing the web configuration. Please follow sections below to check your basic installation status stage by stage.

- Checking if the hardware status is OK or not.
- Checking if the network connection settings on your computer are OK or not.
- Pinging the router from your computer.
- Checking if the ISP settings are OK or not.
- Backing to factory default setting if necessary.

If all above stages are done and the router still cannot run normally, it is the time for you to contact your dealer for advanced help.

4.1 Checking If the Hardware Status Is OK or Not

Follow the steps below to verify the hardware status.

1. Check the power line and LAN cable connections. Refer to “**2.1 Hardware Installation**” for details.
2. Turn on the router. Make sure the **ACT LED** blink once per second and the correspondent **LAN LED** is bright.



3. If not, it means that there is something wrong with the hardware status. Simply back to “**2.1 Hardware Installation**” to execute the hardware installation again. And then, try again.

4.2 Checking If the Network Connection Settings on Your Computer Is OK or Not

Sometimes the link failure occurs due to the wrong network connection settings. After trying the above section, if the link is still failed, please do the steps listed below to make sure the network connection settings is OK.

For Windows



The example is based on Windows 7. As to the examples for other operation systems, please refer to the similar steps or find support notes in www.draytek.com.

1. Open **All Programs>>Getting Started>>Control Panel**. Click **Network and Sharing Center**.



2. In the following window, click **Change adapter settings**.

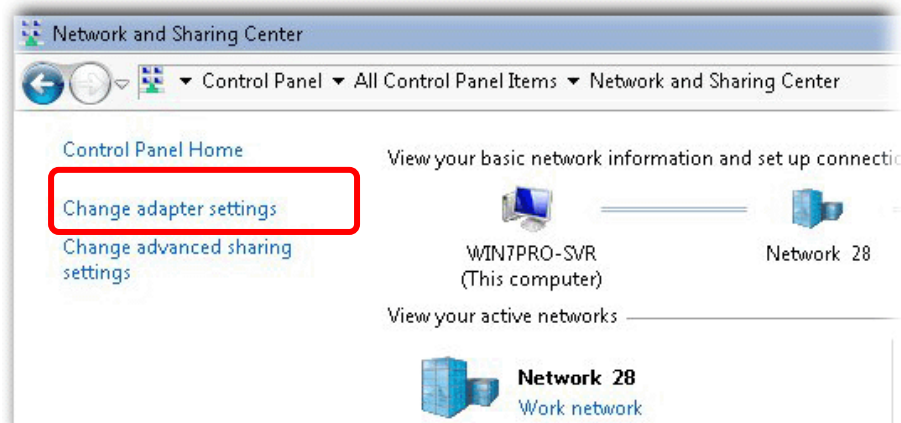

- Icons of network connection will be shown on the window. Right-click on **Local Area Connection** and click on **Properties**.

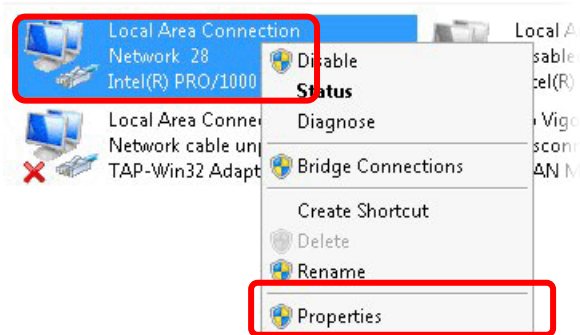

- Select **Internet Protocol Version 4 (TCP/IP)** and then click **Properties**.

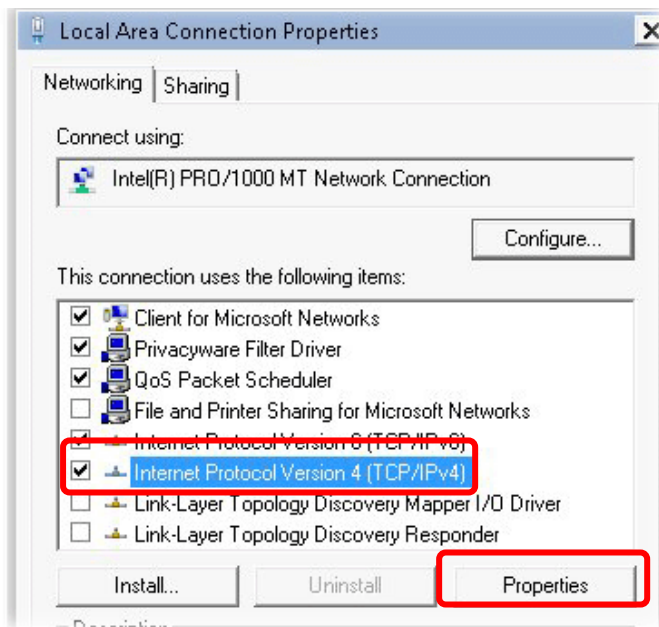

5. Select **Obtain an IP address automatically** and **Obtain DNS server address automatically**. Finally, click **OK**.

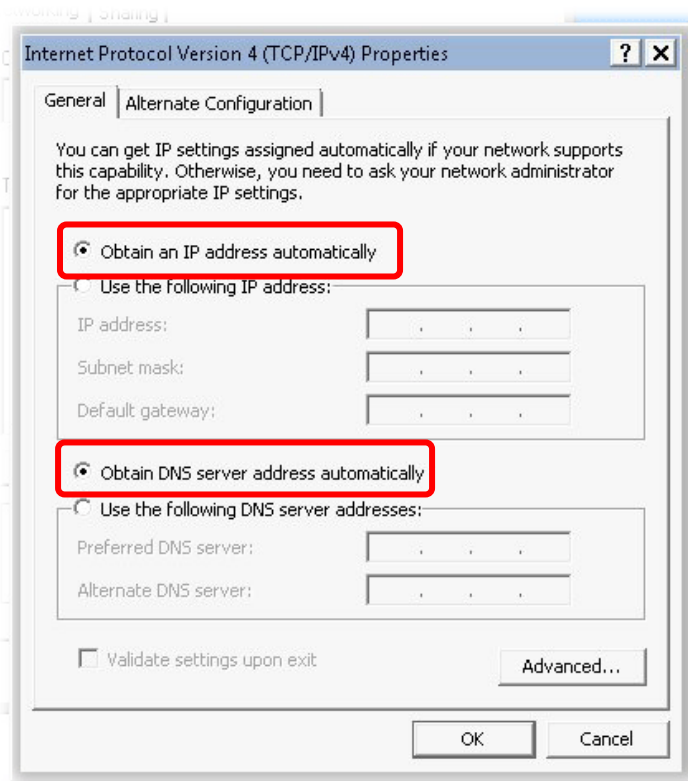

For Mac OS

1. Double click on the current used Mac OS on the desktop.
2. Open the **Application** folder and get into **Network**.
3. On the **Network** screen, select **Using DHCP** from the drop down list of Configure IPv4.

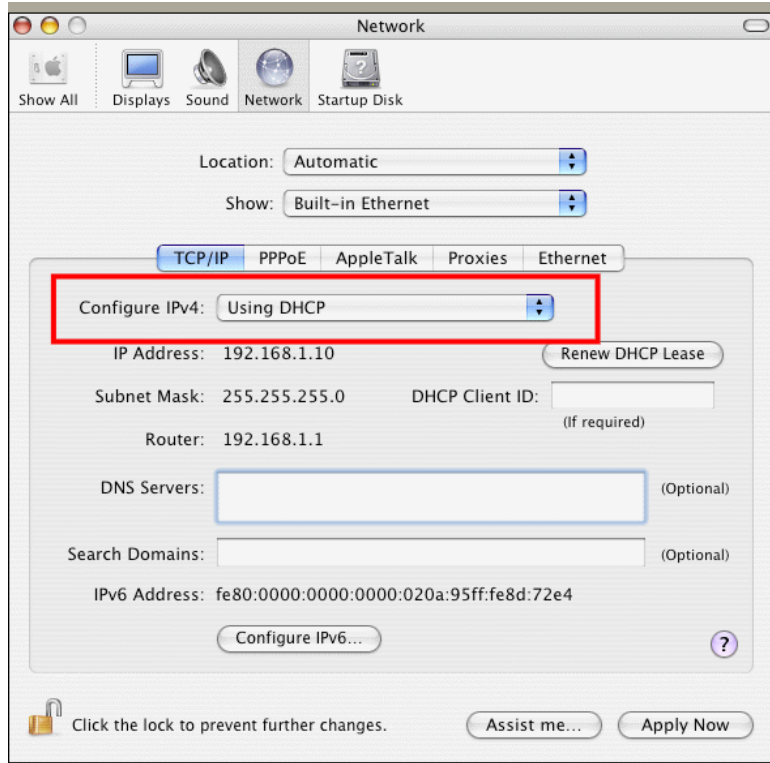

4.3 Pinging the Router from Your Computer

The default gateway IP address of the router is 192.168.1.1. For some reason, you might need to use “ping” command to check the link status of the router. **The most important thing is that the computer will receive a reply from 192.168.1.1.** If not, please check the IP address of your computer. We suggest you setting the network connection as **get IP automatically**. (Please refer to the section 4.2)

Please follow the steps below to ping the router correctly.

For Windows

1. Open the **Command Prompt** window (from **Start menu> Run**).
2. Type **command** (for Windows 95/98/ME) or **cmd** (for Windows NT/2000/XP/Vista/7). The DOS command dialog will appear.

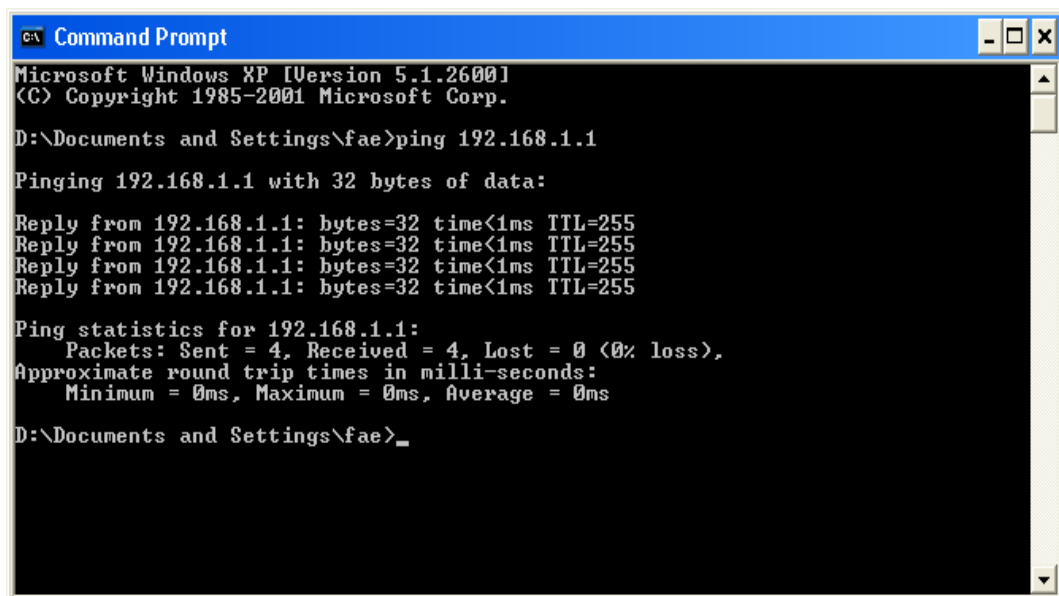

```
Microsoft Windows XP [Version 5.1.2600]
(C) Copyright 1985-2001 Microsoft Corp.

D:\Documents and Settings\fae>ping 192.168.1.1

Pinging 192.168.1.1 with 32 bytes of data:

Reply from 192.168.1.1: bytes=32 time<1ms TTL=255
Reply from 192.168.1.1: bytes=32 time<1ms TTL=255
Reply from 192.168.1.1: bytes=32 time<1ms TTL=255
Reply from 192.168.1.1: bytes=32 time<1ms TTL=255

Ping statistics for 192.168.1.1:
    Packets: Sent = 4, Received = 4, Lost = 0 (0% loss),
    Approximate round trip times in milli-seconds:
        Minimum = 0ms, Maximum = 0ms, Average = 0ms

D:\Documents and Settings\fae>_
```

3. Type **ping 192.168.1.1** and press [Enter]. If the link is OK, the line of “**Reply from 192.168.1.1:bytes=32 time<1ms TTL=255**” will appear.
4. If the line does not appear, please check the IP address setting of your computer.

For Mac OS (Terminal)

1. Double click on the current used Mac OS on the desktop.
2. Open the **Application** folder and get into **Utilities**.
3. Double click **Terminal**. The Terminal window will appear.
4. Type **ping 192.168.1.1** and press [Enter]. If the link is OK, the line of “**64 bytes from 192.168.1.1: icmp_seq=0 ttl=255 time=xxxx ms**” will appear.

```

Terminal - bash - 80x24
Last login: Sat Jan  3 02:24:18 on ttys1
Welcome to Darwin!
Vigor10:~ draytek$ ping 192.168.1.1
PING 192.168.1.1 (192.168.1.1): 56 data bytes
64 bytes from 192.168.1.1: icmp_seq=0 ttl=255 time=0.755 ms
64 bytes from 192.168.1.1: icmp_seq=1 ttl=255 time=0.697 ms
64 bytes from 192.168.1.1: icmp_seq=2 ttl=255 time=0.716 ms
64 bytes from 192.168.1.1: icmp_seq=3 ttl=255 time=0.731 ms
64 bytes from 192.168.1.1: icmp_seq=4 ttl=255 time=0.72 ms
^C
--- 192.168.1.1 ping statistics ---
5 packets transmitted, 5 packets received, 0% packet loss
round-trip min/avg/max = 0.697/0.723/0.755 ms
Vigor10:~ draytek$ █

```

4.4 Checking If the ISP Settings are OK or Not

Open **WAN >> Internet Access** page and then check whether the ISP settings are set correctly. Click **Details Page** of WAN1 to review the settings that you configured previously.

WAN >> Internet Access

Internet Access

Index	Display Name	Physical Mode	Access Mode
WAN1		Ethernet	<div style="border: 1px solid red; padding: 2px;"> None None PPPoE Static or Dynamic IP PPTP/L2TP </div>

[Advanced](#) You can configure DHCP client options

[Details Page](#) [IPv6](#)

4.5 Backing to Factory Default Setting If Necessary

Sometimes, a wrong connection can be improved by returning to the default settings. Try to reset the router by software or hardware.



Warning: After pressing **factory default setting**, you will lose all settings you did before. Make sure you have recorded all useful settings before you pressing.

Software Reset

You can reset the router to factory default via Web page. Go to **System Maintenance** and choose **Reboot System** on the web page. The following screen will appear. Choose **Using factory default configuration** and click **Reboot Now**. After few seconds, the router will return all the settings to the factory settings.

System Maintenance >> Reboot System

Reboot System

Do you want to reboot your router ?

- Using current configuration
- Using factory default configuration

Reboot Now

Auto Reboot Time Schedule

Index(1-15) in **Schedule** Setup: , , ,

Note: Action and Idle Timeout settings will be ignored.

OK

Cancel

Hardware Reset

While the router is running (ACT LED blinking), press the **RST** button and hold for more than 5 seconds. When you see the **ACT** LED blinks rapidly, please release the button. Then, the router will restart with the default configuration.

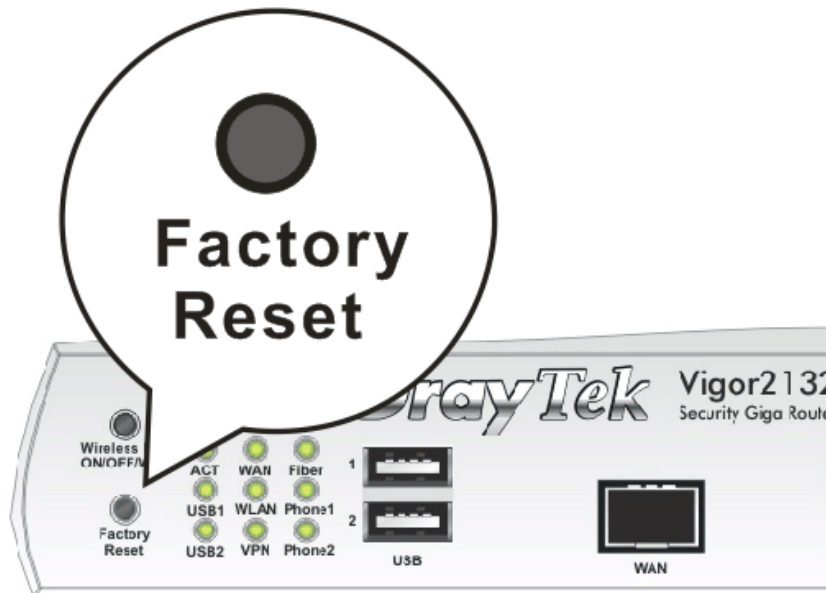

After restore the factory default setting, you can configure the settings for the router again to fit your personal request.

4.6 Contacting DrayTek

If the router still cannot work correctly after trying many efforts, please contact your dealer for further help right away. For any questions, please feel free to send e-mail to support@draytek.com.